

# NRSA Series

## SMD Power Inductors For Automotive

### Size 3015B

#### FEATURES

- Temperature rise)
- AEC-Q200 qualified
- 
- 
- 
- Quantity: 2000pcs

#### APPLICATION

- Car navigation, car stereo and car accessories only

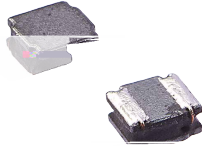

#### Dimensions: [mm]

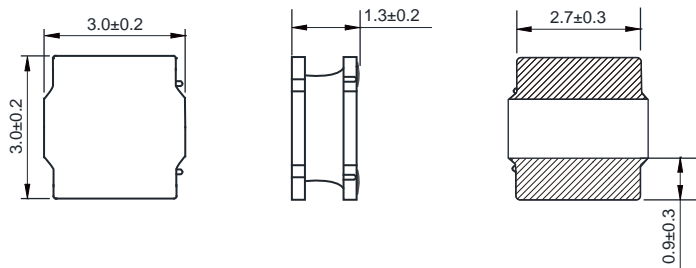

#### Land Pattern: [mm]

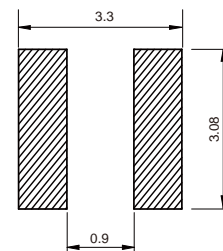

#### Electrical Properties:

Part No	Inductance @ 100KHz/1V	Tolerance	Temperature Rise Current Typ. (A)	Temperature Rise Current Max. (A)	Current Typ. (A)	Current Max. (A)	DC Resistance ±20%
NRSA3015B-R47N	0.47	±30%	3.70	3.30	4.30	4.00	22
NRSA3015B-R68N	0.68	±30%	3.50	3.20	3.80	3.20	26
NRSA3015B-1R0M	1.00	±20%	3.00	2.70	3.00	2.40	
NRSA3015B-1R5M	1.50	±20%	2.70	2.50	2.40	2.00	38
NRSA3015B-2R2M	2.20	±20%	2.50	2.30	2.10	1.90	60
NRSA3015B-3R3M	3.30	±20%	2.20	2.00	1.70	1.50	85
NRSA3015B-4R7M	4.70	±20%	1.90	1.70	1.50	1.30	112
NRSA3015B-5R6M	5.60	±20%	1.80	1.60	1.40	1.20	135
NRSA3015B-6R8M	6.80	±20%	1.70	1.50	1.30	1.10	172

Saturation Current will cause L to drop approximately 30%

Temperature Rise Current: The actual value of DC current when the temperature rise is  $\Delta T=40^{\circ}\text{C}$

# Typical Electrical Characteristics:

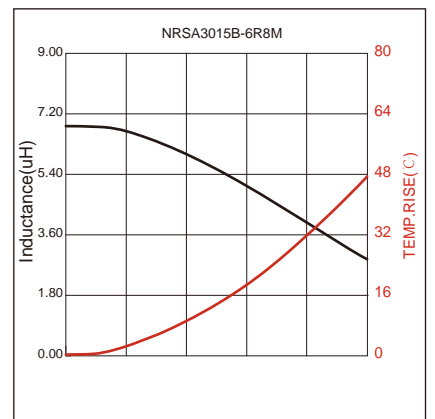
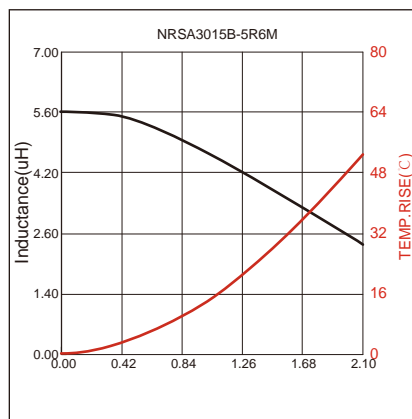
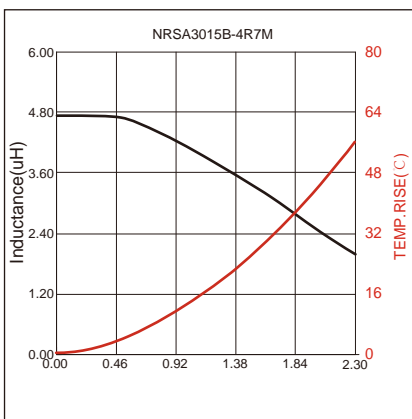
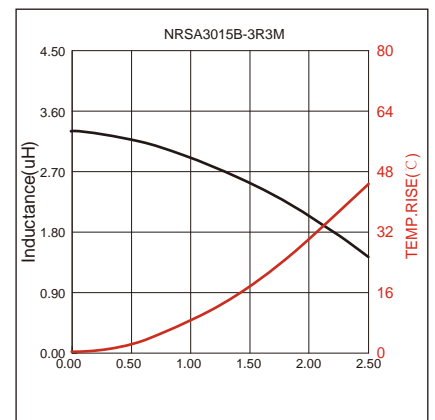
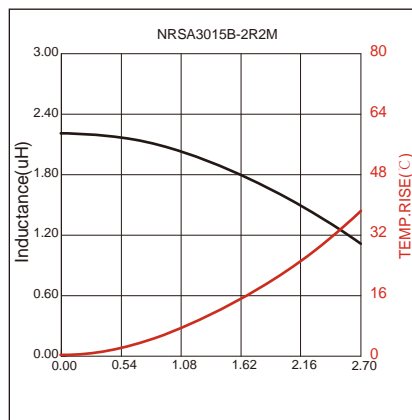
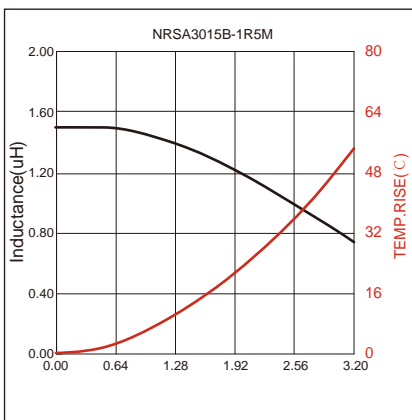
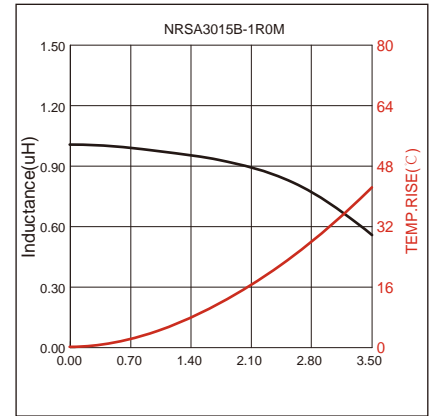
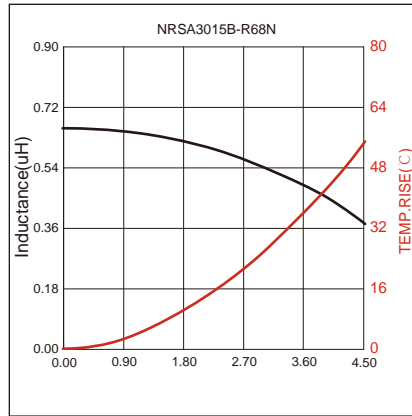
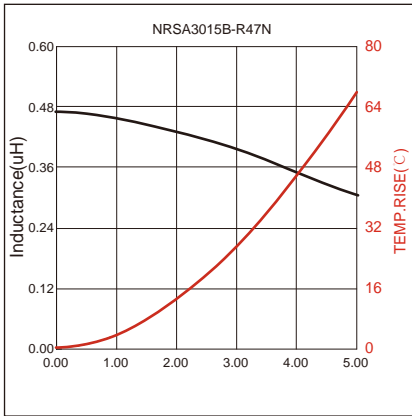

## Soldering Reflow:

## Packaging Information:

### Tape Dimension :

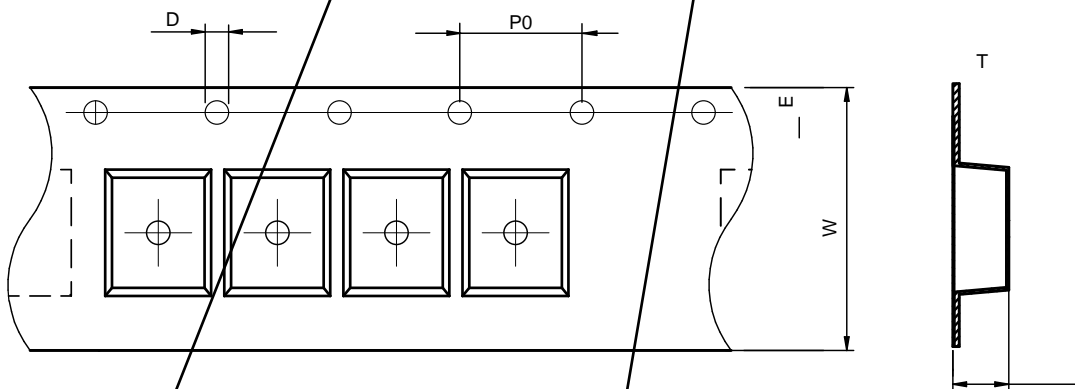

Series	A0 (mm)	B0 (mm)	D (mm)	P0 (mm)	P1 (mm)	W (mm)	K0 (mm)	E (mm)	T (mm)
NRSA3015B	3.2±0.1	3.2±0.1	1.5±0.1	4.0±0.1	4.0±0.1	8.0±0.3	1.7±0.1	1.75±0.1	0.30±0.05

### Peel force of top cover tape:

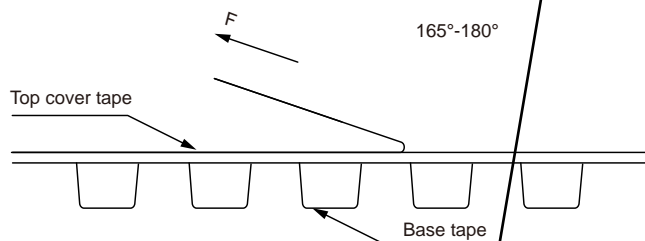

The peel force of top cover tape shall be between 0.3 to 1.17 N

## Reel Dimension: [mm]

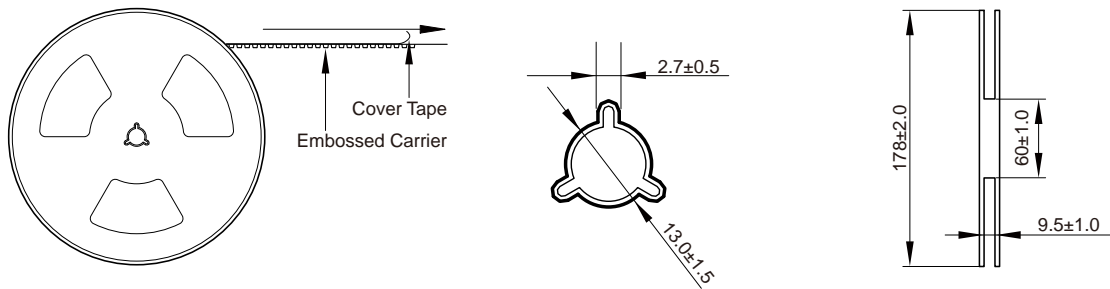

## Packaging Quantity:

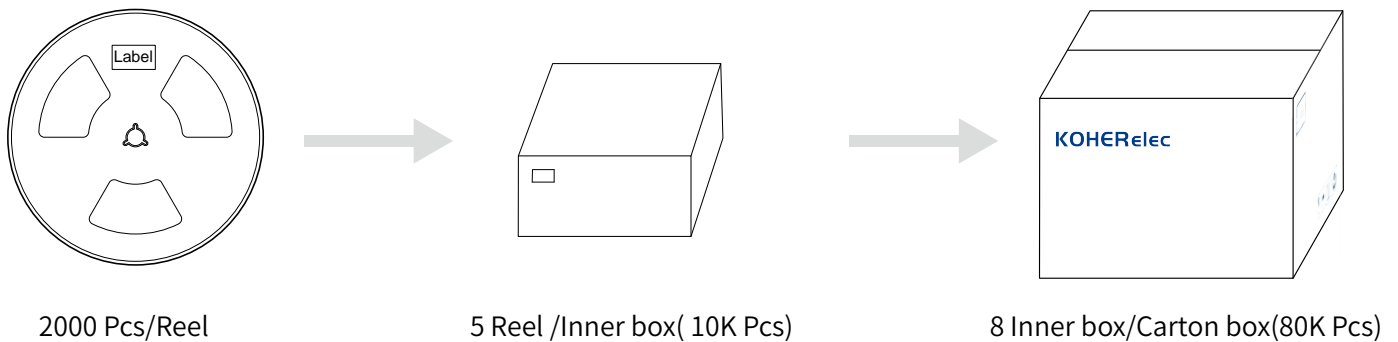

## Cautions and Warnings:

### Storage Conditions :

- The storage period is within 12 months after the completion of production. Be sure to follow the storage conditions (temperature: -5 to 35°C, humidity: 75% RH Max).If the storage period elapses, the soldering of the terminal electrodes may deteriorate.The warranty period is one year.
- Product should not be exposed to environment with high temperature, high humidity, dust, corrosive gas and etc.
- Products should be handled with care to avoid damage or contamination from perspiration and skin oils.
- Please always handle products carefully to prevent any damage caused by dropping down or inappropriate removing.

### Operation Instructions:

- Self heating (temperature increase) occurs when the power is turned ON, so the tolerance should be sufficient for the set thermal design.
- Before soldering, be sure to preheat components.The preheating temperature should be set so that the temperature difference between the solder temperature and chip temperature does not exceed 150°C.
- Soldering corrections after mounting should be within the range of the conditions determined in the specifications.If overheated, a short circuit, performance deterioration, or lifespan shortening may occur.
- Generally, Koher might not be familiar with either customer's specific application or actual requests as customer does.As a result customer shall be responsible for checking and confirming whether Koher product with the performance described in the product specification is suitable for using in customer's particular application or not.