

# FBE Series



## CHARACTERISTICS

- 
- 
- 
- 
- 

## APPLICATION

- 
- 

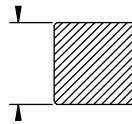
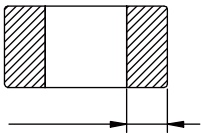

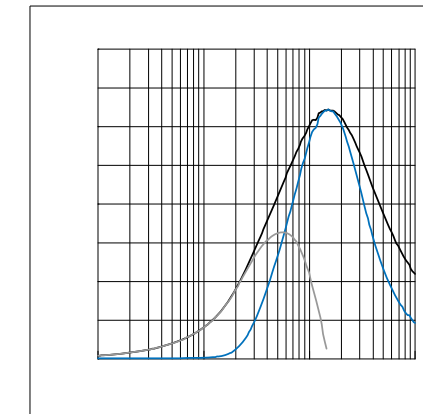
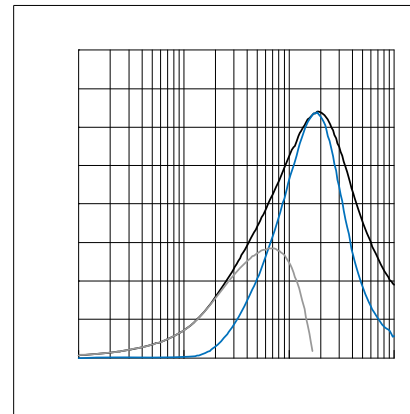
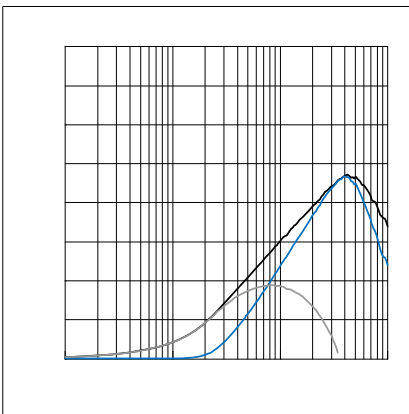
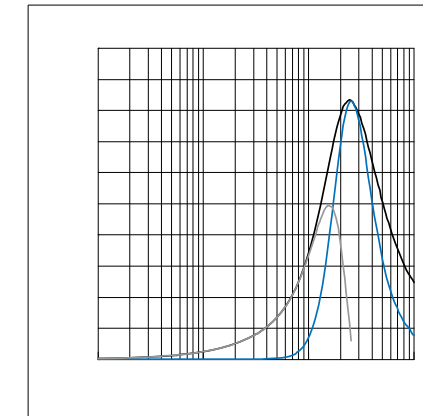
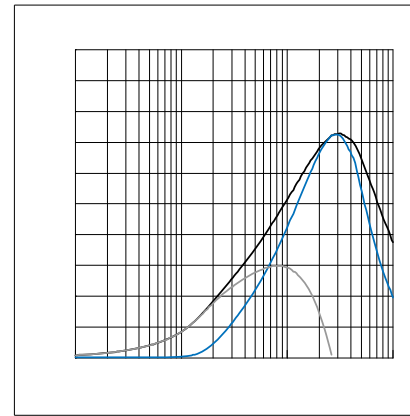
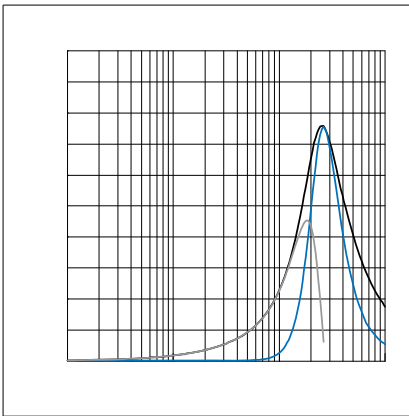
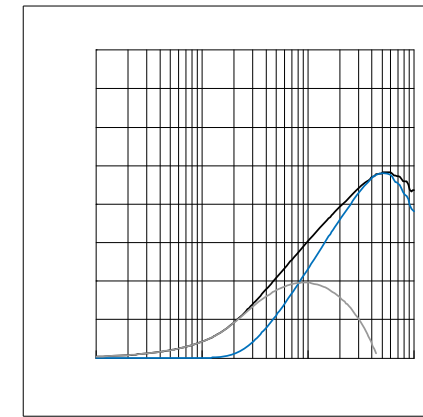
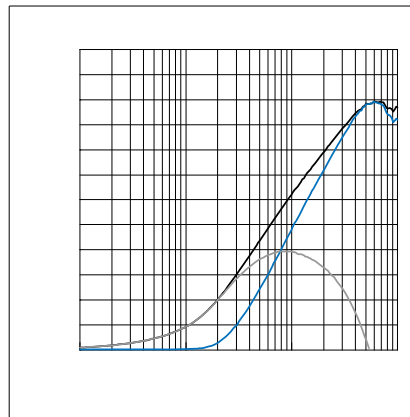
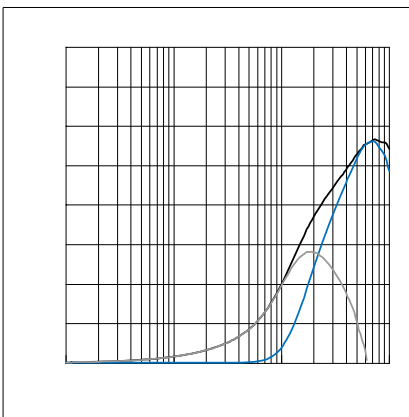
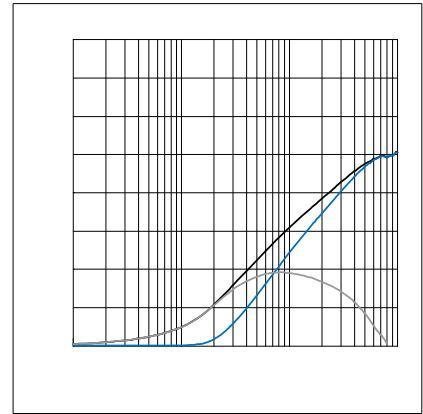
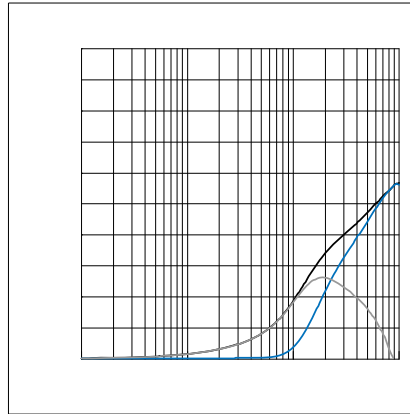
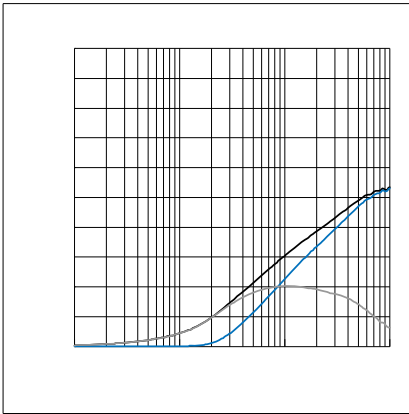



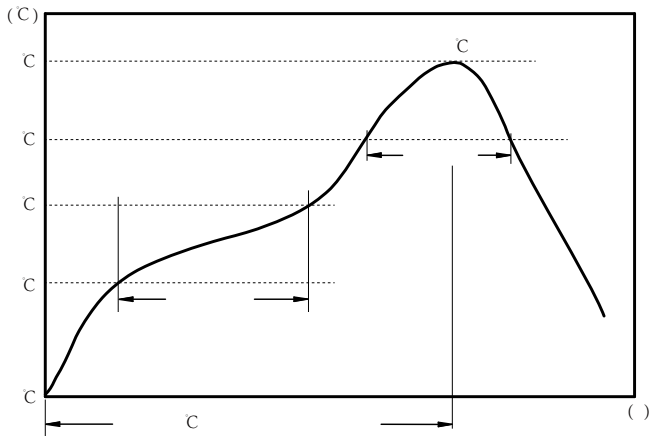

C  
C  
C

:

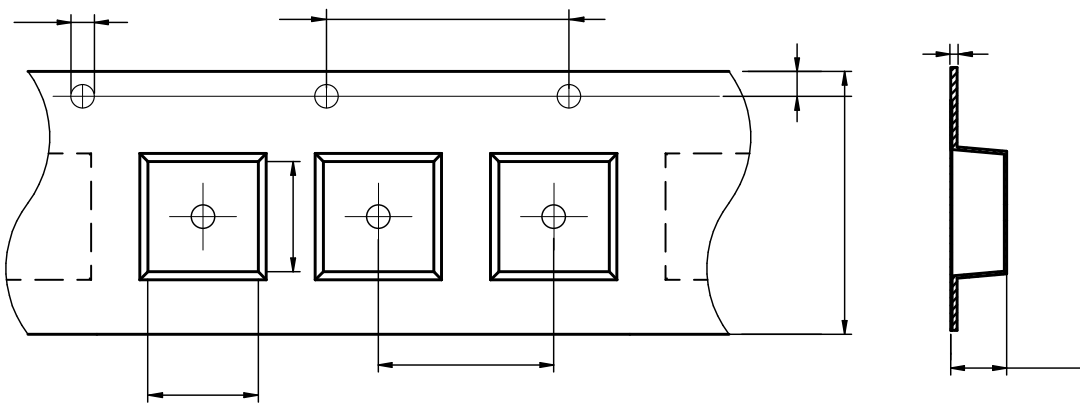

FBE0402	$0.62 \pm 0.03$	$1.12 \pm 0.03$	$1.5 \pm 0.1$	$4.0 \pm 0.1$	$4.0 \pm 0.1$	$8.0 \pm 0.3$	$0.60 \pm 0.03$	$1.75 \pm 0.1$	$0.60 \pm 0.03$
---------	-----------------	-----------------	---------------	---------------	---------------	---------------	-----------------	----------------	-----------------

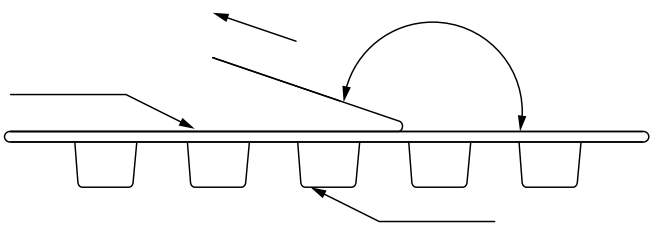

The peel force of top cover tape shall be between 0.14 to 0.58 N

:

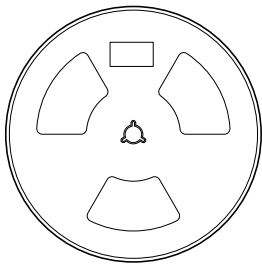
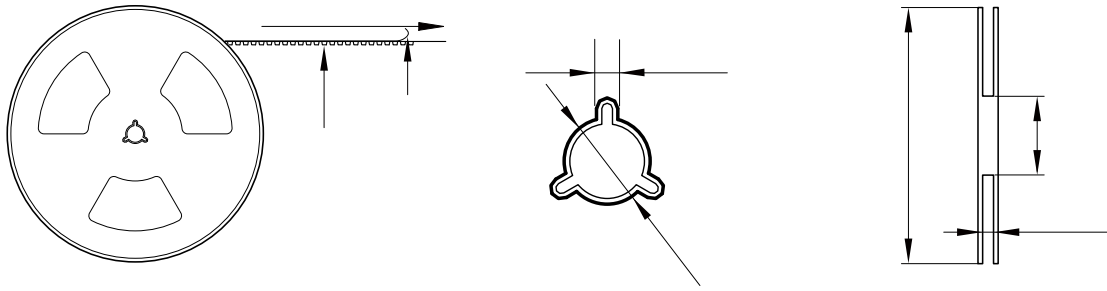

10000 Pcs/Reel

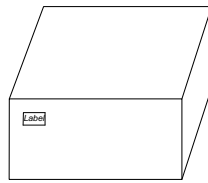

5 Reel /Inner box( 50K Pcs)

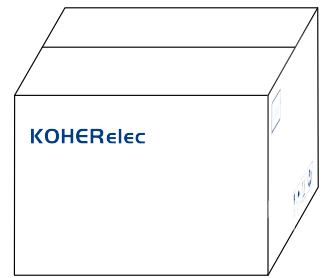

8 Inner box/Carton box(400K Pcs)

:

- 
- 
- 
- 
- 
- 
- 
- 
-