

o o C F M Auo o o dæ v t e r s r t S L e g e
S 2 2 e 3



-
-
-
-
-

■ Ethernet system.

o] e s [s 2 aP a L] d t

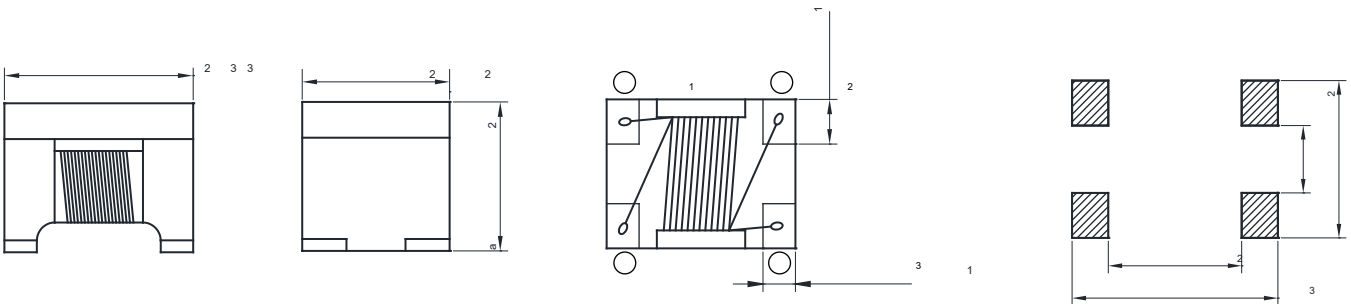

Pa p o e t r r e r t e s

	(μ H)		(mA)	()	(V)	(M)

c c y a Tæ a c C e t r h r t e r s t s

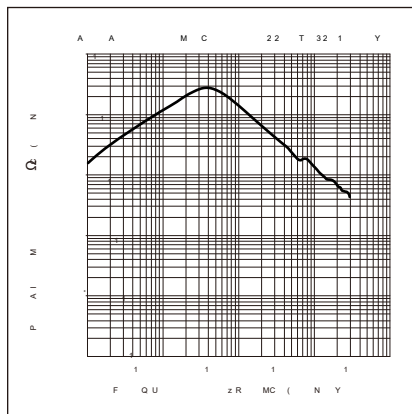
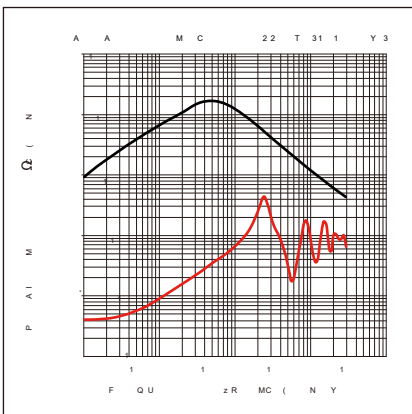



o fS R d e r g e

P ca o o ~ re he t 1C d t 2 1 2
 A o a o ~v e d t 2e 1 b e 1 se

o l a o f g g r t
 o T : e e s

A	S (eres)	(P (B	P ((W 1 K	(((
ACMA3225ETH	2.88±0.1	3.72±0.1	1.5±0.1	4.0±0.1	4.0±0.1	8.0±0.3	2.5±0.1	1.75±0.1	0.26±0.05

c o p c d o p f a v e e r e t e r t e

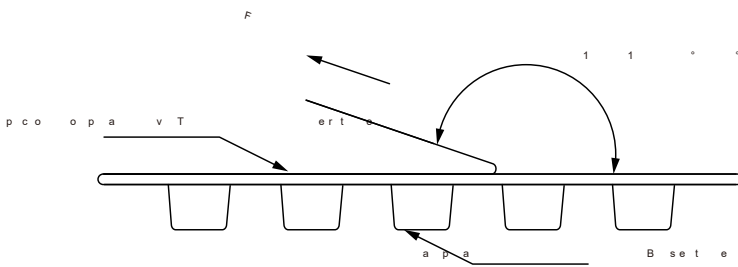

The peel force of top cover tape shall be between 0.14 to 0.78 N



o R :] ee e s [

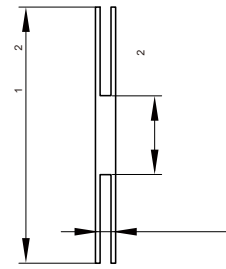
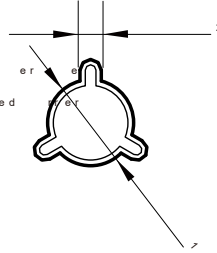
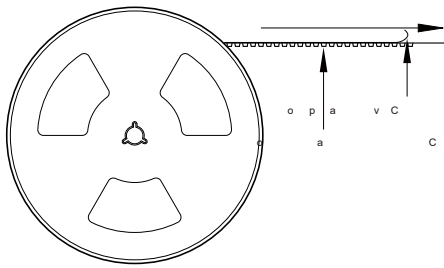

a a u Q a y g g t t

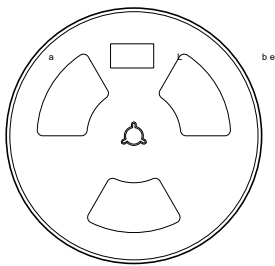

2000 Pcs/Reel

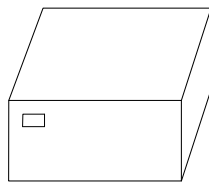

5 Reel /Inner box(10K Pcs)

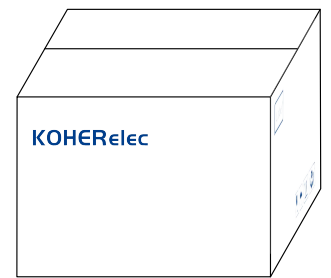

8 Inner box/Carton box(80K Pcs)

o a Ca W t s d r g s

oa o o S :t r ge d t s

o p u a (o u s te er Cre%y ta 3 ° Ml odft opa the s br ge or de s es the s der g t ac o a teroay ee ta daps de lery o te ane rry t er d s e e r

P uco d o o p o r do t shod v be e sp d t uea r au t th h gh t e ery to re h gh ha v d t d st rr s e g c et

P uco u o a cr d ats shoa db eah ad edo tlo are ta o dpa p gef ar o a t or ers r t d s

P a a a p yuco c e ae p sh f d e ar d vats ac ney a t rep e d yd o g eppa sped b adr g d r r o v re g

a o u c l o O er t str t s

a p u a 8 (ea h eub g te erpt re o re use rs heo the ocaer su r o d Q cs the t erff e sh d be s o f a r the set ther des g

o o f u p o Be ae sp d er og be spre t reah e tp Tu ae tsu heo rehe t g te a er t re sh d be sets th t th p u a c ff te er t o e d pere u a bet a e p the p de u te er bre ed h te er t red es t Ce eed °

o c co o a S u o d e r g orre t s ter a t gos h do bef dh the r ge th p e c d t as dete r f ed the s o o l a f va cocut ps eoh ea ted f sh rda ro to p r ra e f d e t e r r t ac cu o r e sy sh r te g r

a Ko y o ea era f hercu ght d bep c c rpp a e thae r o s o u a er s u e cau t o r t requests s

A au cu o da es ps ros t cs o c er shf abe reso s be rf he K d i co r g h e t h e r her r d t t oca e p eur cor p c ecdesar b e d f the r u d o t s e c u f t o s p s t c a b e p p a c g a o t o e r s r t r o

o t